

TECHNICAL DATA

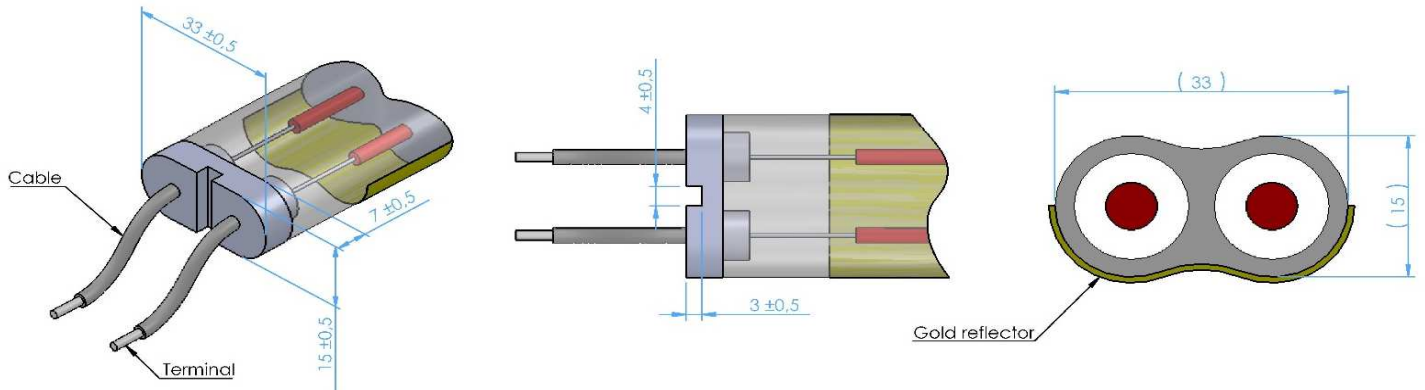
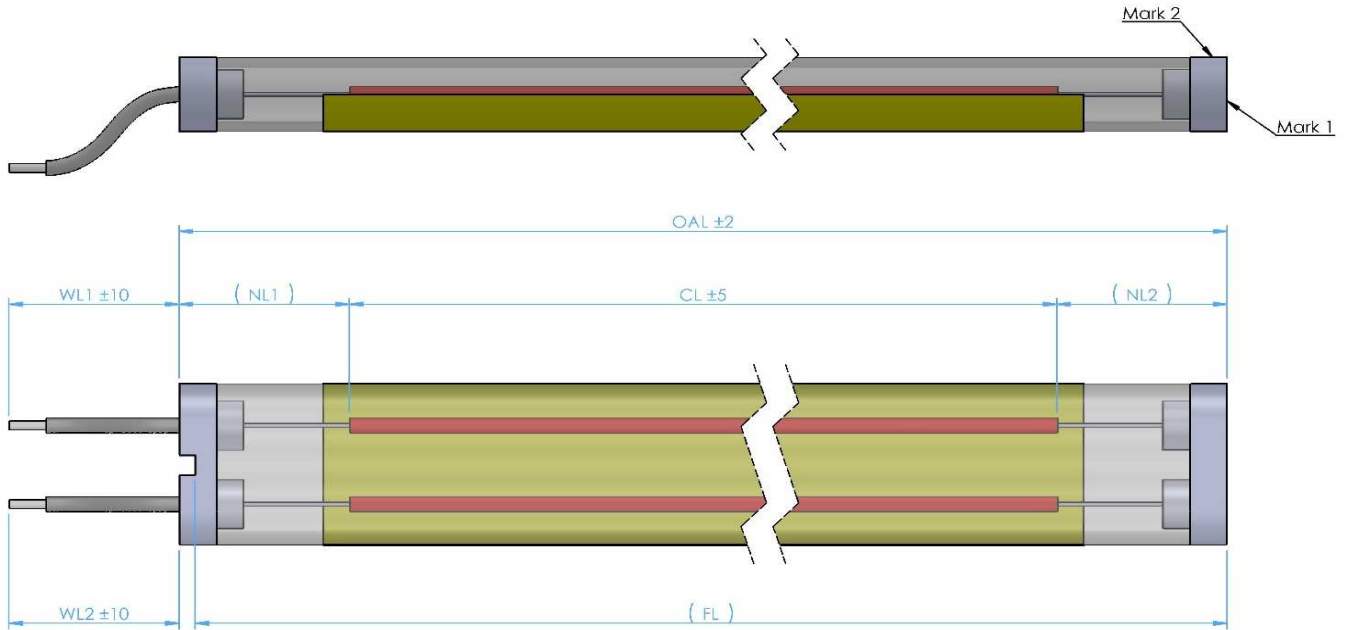

1° - Electrical data :

Nominal voltage	Wattage	Average life time*	Wire T°	Lighting position
400 V	4500 W ± 5%	10000 Hrs	850 °C	Horizontal ±4°

* with AC power supply, 50 or 60 Hz, continuously at room temperature and free from vibration.

2° - Dimensional data :

OAL	CL	FL	NL1	NL2
1920 ± 2 mm	1800 ± 5 mm	(1917 mm)	(60 mm)	(60 mm)

3° - Cable data :

Cable Type	Terminal	WL 1	WL 2
Silicable CNVAS 1mm ² 400° (grey) OMERIN or equivalent	End Stripped (7mm)	500 ± 10mm	500 ± 10mm

4° - Marking :

Mark 1	Mark 2
DHKG400V4500W 1800S15KH	DIRTECH + Lot

Emitter type
B

Twin Tube Medium Wave Emitter			Modif	0					
			Date	21/03/2016					
DHKG 400V 4500W 1800 S15 K - H			Comments						
Date	DIRTECH®	Drawing number	Original						
21/03/2016		IRM-156							