

# TECHNICAL DATA

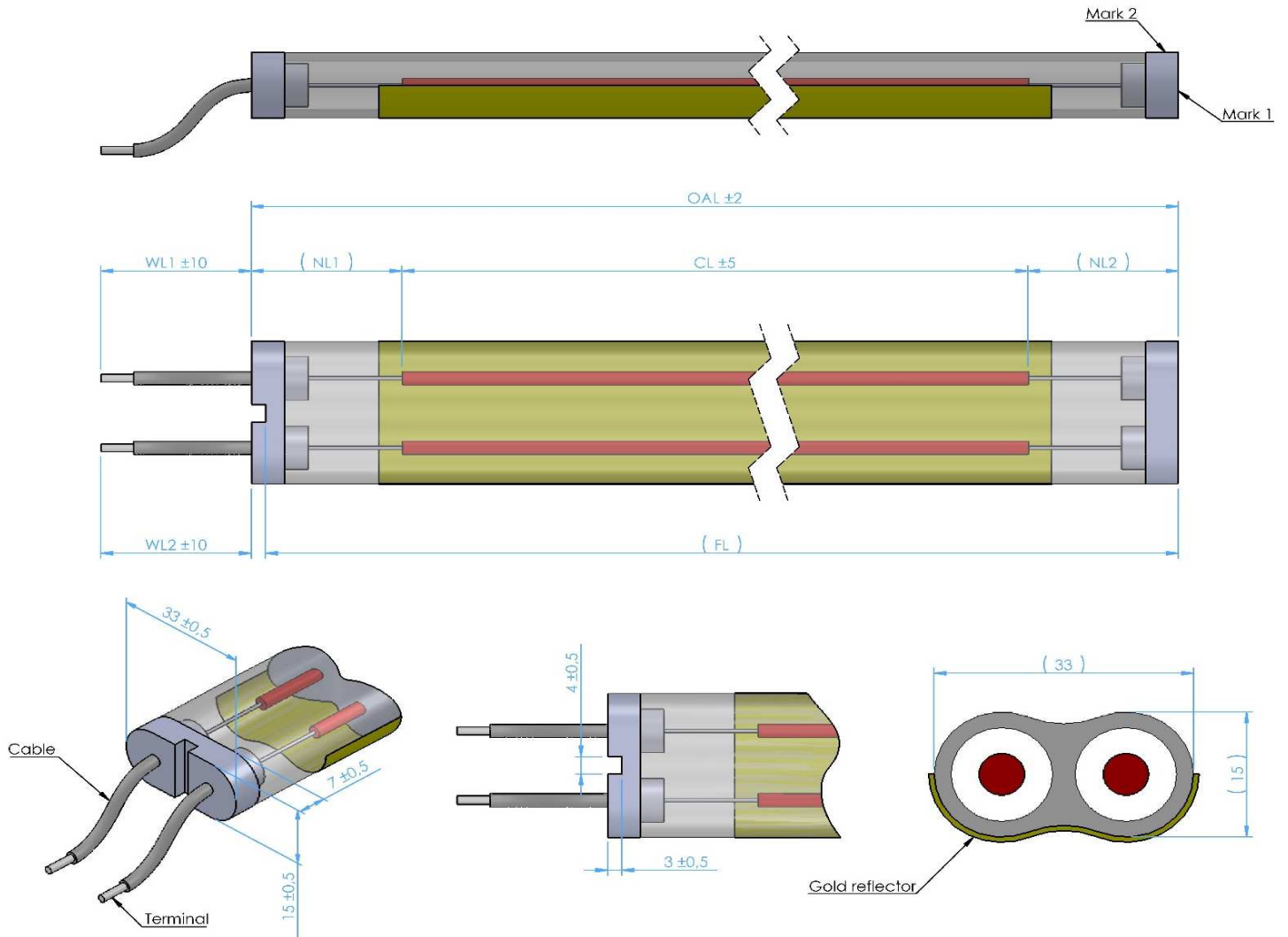

### 1° - Electrical data :

Nominal voltage	Wattage	Average life time*	Wire T°	Lighting position
230 V	2000 W ± 5%	10000 Hrs	850 °C	Horizontal ±4°

\* with AC power supply, 50 or 60 Hz, continuously at room temperature and free from vibration.

### 2° - Dimensional data :

OAL	CL	FL	NL1	NL2
900 ± 2 mm	800 ± 5 mm	(897 mm)	(50 mm)	(50 mm)

### 3° - Cable data :

Cable Type	Terminal	WL 1	WL 2
Silicable CNVAS 1mm <sup>2</sup> 400° (grey) OMERIN or equivalent	End Stripped (7mm)	500 ± 10mm	500 ± 10mm

### 4° - Marking :

Mark 1	Mark 2
DHKG230V2000W 800S15KH	DIRTECH + Lot

Emitter type
B

<b>Twin Tube Medium Wave Emitter</b>			Modif	0					
			Date	21/03/2016					
<b>DHKG 230V 2000W 800 S15 K - H</b>			Comments						
Date	<b>DIRTECH®</b>	Drawing number	Original						
21/03/2016		<b>IRM-151</b>							