

OAL	353	WL	230
CL	285	Mark 1	DIRTECH + lot
AL	280	Mark 2	DC235V2000W 285BfH1

Wire: SILIFLON UL 1727 AWG 18 250°C Color: WHITE
OMERIN or equivalent

Terminal: Splice RSB 7792.002V-1.5 STOCKO or equivalent

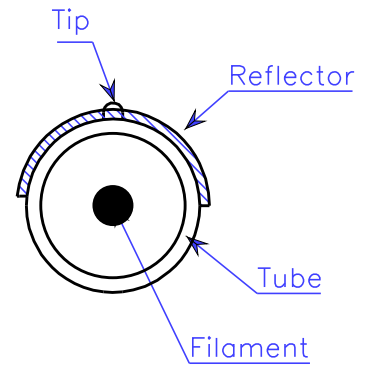

Specifications:

Nominal voltage: 235 V

Wattage: 2000 W ± 5%

Average life: 5000 Hrs (with AC power supply, 50 or 60 Hz, continuously at room temperature and free from vibration)

Lighting position: Horizontal ±4°

Strength test:

- Wire harness shall withstand tensile load of 5 Kgf in lamp axis direction.

Tc 2450°K

Type: InfraRed Halogen Heater Lamp DC 235V 2000W 285 BfH1		Modif.:	
		Date:	
Date: 24-01-14	DIRTECH	Version IC-179	Comments