

OAL	353		
CL	280	Mark 1	DIRTECH + lot
WL	230	Mark 2	DC235V2000W 280BH

Wire: SILIFLON UL 1727 AWG 18 600V 250°C (white)
OMERIN or equivalent

Terminal: Splice RSB 7792.002V-1.5 STOCKO or equivalent

Specifications:

Nominal voltage: 235 V

Wattage: 2000 W ± 5%

Average life: 5000 Hrs (with AC power supply, 50 or 60 Hz,
continuously at room temperature and free from vibration)

Lighting position: Horizontal ± 4°

Tc 2425 K

Strength test:

- Wire harness shall withstand tensile load of 5 Kgf in lamp axis direction.
- Insulator base shall withstand tensile load of 5 Kgf in lamp axis direction.

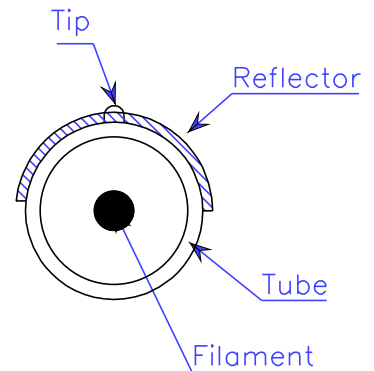

Type: InfraRed Halogen Lamp Heater
DC 235V 2000W 280 BH

Modif.:

Date:

Date:
27-10-13

DIRTECH

Version
IC- 074

Comments