

OAL	275		
CL	210	Mark 1	DIRTECH + lot
WL	600	Mark 2	DC220V2000W 210BfH

Wire: SILIFLON UL 1727 AWG 18 600V 250°C (white)
OMERIN or equivalent

Terminal: End stripped (7 mm)

Specifications:

Nominal voltage: 220 V

Wattage: 2000 W ± 5%

Average life: 5000 Hrs (with AC power supply, 50 or 60 Hz,
continuously at room temperature and free from vibration)

Lighting position: Horizontal ± 4°

Tc 2500 K

Strength test:

– Wire harness shall withstand tensile load of 5 Kgf

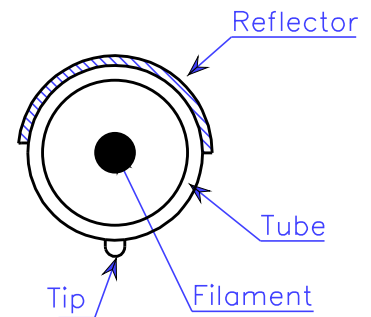

Type: InfraRed Halogen Heater Lamp
DC 220V 2000W 210 BfH

Modif.:

Date:

Date:

07-03-16

DIRTECH

Version

IC-691

Comments